

# COLOURPANEL™

 Boundaryline

A STEP-BY-STEP GUIDE TO INSTALLING YOUR FENCE



# INSTALL GUIDE

# INTRODUCTION

Thank you for choosing Boundaryline ColourPanel™ Fencing. This product will provide you with many years of trouble free protection if installed in accordance with the directions outlined in this document.

The recommendations detailed in this guide are formulated along the lines of good building practice. They are not intended to be an exhaustive statement of all the relevant data.

If you have any questions, please contact our Technical Team on 0800 003 006. We are always happy to help in any way we can.

## BEFORE YOU START, READ THIS

- This guide does not apply to any fences over 1.8m in height. If your fence is greater than 1.8m, please seek further advice from Boundaryline.
- Describe your site details when ordering materials.
- Identify your soil type/ ground conditions. Refer to

the table in Step 1. This will determine the concrete and footing details required.

- Make sure you are aware of underground services before you start digging! These could be gas, electricity, or water mains. Call your local council for more information.

- Check your local council regulations on boundary fencing.
- Check the delivered material for the correct number of components and general condition before beginning your installation.

## TOOLS LIST



- Make sure you choose the right tools before start installing your fence.

### TOOLS

- Tape Measure
- Square
- Shovel
- Circular Saw
- Hex Drive Bit
- Line Marking Paint
- String Line
- Drill/Driver
- Angle Grinder
- Post Hole Digger
- Spirit Level

### SAFETY GEAR

- Safety Boots
- Gloves
- Helmet
- Eye Protection
- Hearing Protection
- Sun Protection



It is recommended that the reader pays particular attention to those items identified as IMPORTANT in this manual to ensure satisfactory long-term performance.

# A STEP-BY-STEP GUIDE TO INSTALLATION

## STEP 1 - MARKING OUT YOUR POST HOLES

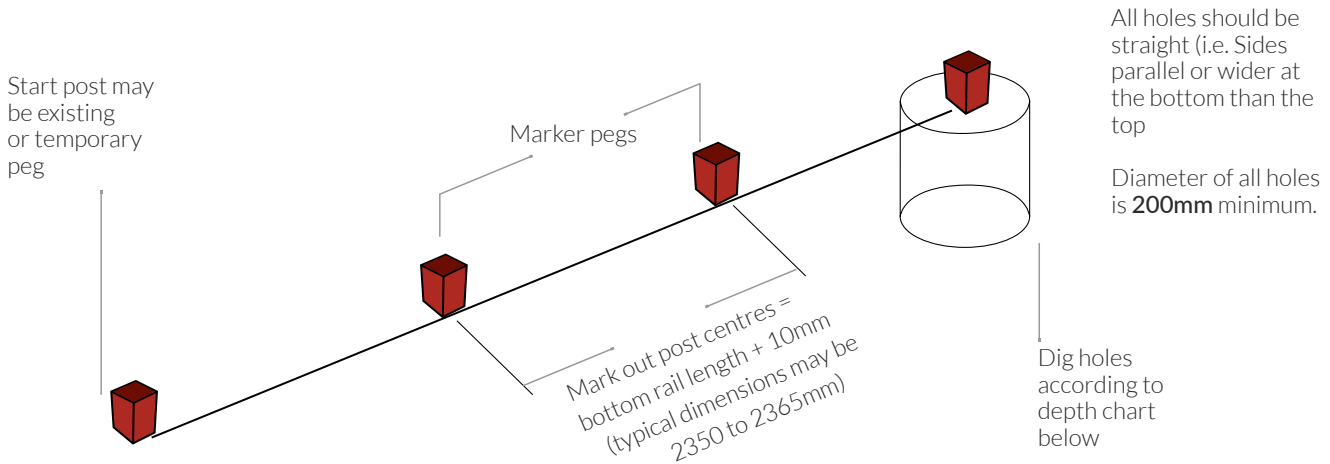

**IMPORTANT**

Post lengths required will increase accordingly to cater for these ground conditions.

Soil Type	Minimum Hole Depth	Approximate Concrete Required
Rock	300mm	1 bag per hole (20Kg bag)
Clay/Firm Earth	600mm	2 bag per hole (20Kg bags)
Sand/Loose Fill	900mm	3 bag per hole (20Kg bags)

## SLOPING OR UNEVEN SITES

### Uneven sites

Vertical slitting of sheets may be required if slope is greater than 1 in 8. This may reduce the three sheet coverage to a point where one of the sheets may require vertical slitting. On ColourPanel™ steel this can be achieved using a straight edge and scoring with a tungsten tipped hand cutter available at most hardware stores, then bending and snapping the sheet.

The top rail angles can be adjusted to create a smoother angle if desired. Note that the post height required will increase, so allow for this when fixing the posts in the ground.

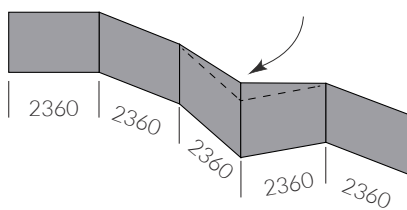

We have longer rails available, so when you have a slope in your fence line, you can keep your post centres at the standard intervals.

### a. Marking out sloping sites

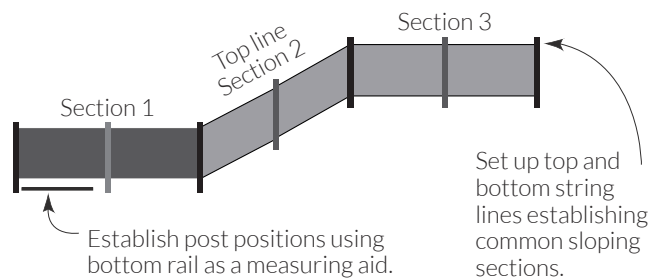

### b. Cutting of sheets for a raked fence

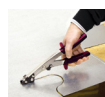
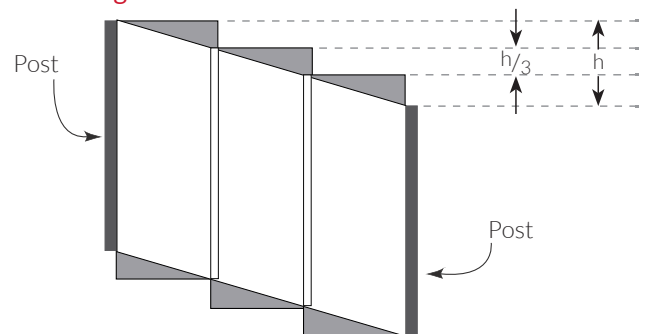

The preferred method of cutting sheets is to use a nibbler or tin snips.

## STEP 2 – SECURING POSTS

### a. Fastening posts together

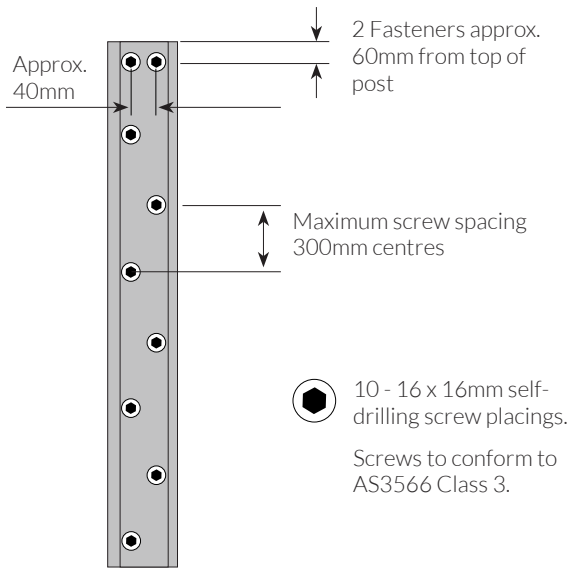

If it isn't possible to fix posts as proposed here, please contact us for further information.

### b. Fixing post in ground

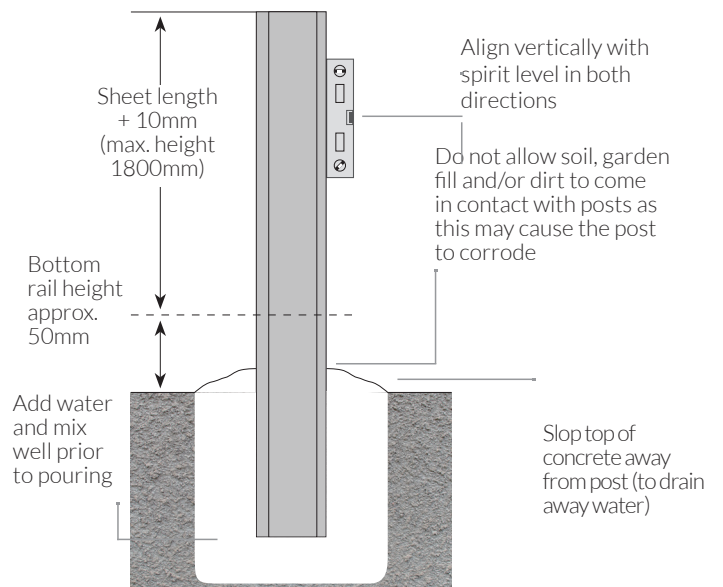

- Place first post in hole
- Adjust to correct height
- Support post with temporary brace
- Fill hole with fully mixed, wet concrete
- Vibrate and compact the concrete to remove voids.

## TYPICAL INSTALLATION OPTIONS FOR END POSTS, CORNER POSTS AND JUNCTIONS

□ - 65mm SHS Section    □ - Fence Post

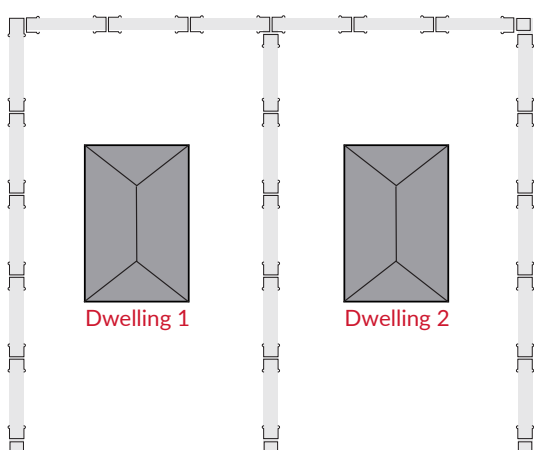
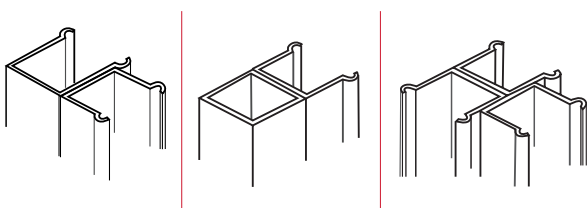

## TAPERING THE FRONT OF YOUR FENCE

It is highly recommended that you taper the last two panels of your fence at an unsupported end, particularly where your fence extends beyond the front of your house.

Cut sheets as per the instructions in the 'sloping or uneven sites' section.

The minimal extra effort in tapering the unsupported end will provide a better looking fence than a stepped fence and is much stronger than leaving it at full height.

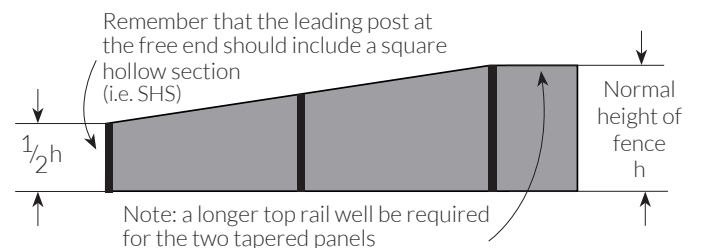

### Example for 2365mm post centres

Fence Height	Tapered End Height	Top rail length if tapered per two panels
1500mm	750mm	2385mm
1800mm	900mm	2400mm

## STEP 3 – INSTALLING INFILL SHEETS

- Insert bottom rail between posts to determine exact location of next post.
- Adjust bottom rail to correct height - it is important to maintain a minimum gap of 50mm between bottom of rail and ground.
- Screw fix the rails at this stage.
- Place top rail into post and fix with self drilling screws on both sides of posts. Ensure that the self-drilling screws are not fully tightened, as they need to be removed when inserting sheets. Ensure the position of the top rail is protruding 2mm above the top of the posts to reduce the risk of injury.
- Continue this procedure until fence length is achieved.
- Allow the concrete to cure overnight. Note: Longer curing period may be required in very cold and/or wet weather.
- Unscrew top rail and remove.
- Fit infill sheets into bottom rail ensuring correct lap as per diagrams (right).
- Place top rail on infill sheets working from one end to the other, locating the profile in the rail. A gentle tap with a rubber mallet may help.
- Secure the top rail with self-drilling screws on both sides.
- Hose down with good water pressure when finished to remove any swarf such as drill filings or remnants from the nibbling process.
- Check installation.

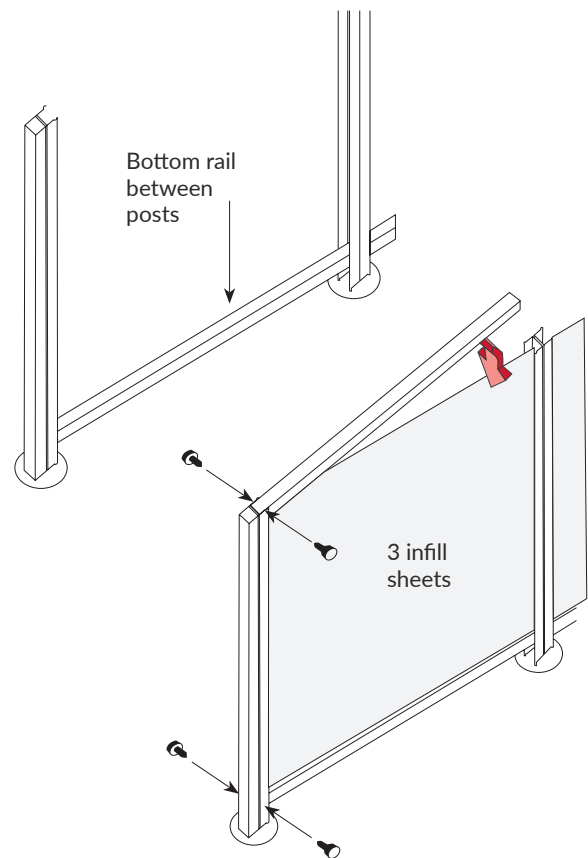

Correct lap detail for various infill sheet profiles.

## STEP 4 – INSTALLING POST CAPS

All ColourPanel™ caps are supplied as a 'double' cap, which are designed to be snapped in half to create two single caps where required.

### 1



Cut each side of the cap in line with the centre ridge. Use end-nippers – do not use a knife as this is dangerous and difficult to achieve a straight cut.

Ensure the 'nose' of the end nippers is pushed all the way in before cutting.

### 2



Bend the cap along the centre ridge to snap it, and pull apart to create two single caps.

## NOTES

If the cap is not a tight fit, place a small amount of silicone up inside the cap to secure it. Make sure the silicone is a small bead on the inside corner of the sides only.

Make sure you keep the correct distance from the top of the post to the top of the rail (see page 5).



## MAINTENANCE AND WARRANTY OF YOUR FENCE

1. To keep your fence looking its best, simply wash down periodically with water when cleaning the car or watering the garden. A soft broom should be sufficient to remove any cobwebs. Pay particular attention to the area under the top rail, which is sheltered from natural washing by rain.

2. **DO NOT** build up soil, garden fill and/or dirt against the bottom rails and posts of your fence as this will retain water and lead to corrosion.

**DO NOT** use your fence as a retaining wall, as it is not designed for this purpose.

3. Avoid spraying the fence with garden sprays or fertilisers as these can damage the surface. If this occurs wash the fence down with water.

Adequate drainage is needed to ensure that water does not pond in the bottom rail and to assist in the removal of debris. This is often achieved by pre-punched holes in the bottom rail, or by designing the posts such that there is a clearance between the ends of the bottom rail and the posts.

4. **DO NOT** use touch up paint. Minor scratches should be left alone or the infill sheet replaced. Touch up paint will weather differently than ColourPanel™ steel. A small touch up brush can be supplied for any small scratches.

5. Fencing is backed by a 10-year warranty\* under the following conditions:

- Installation > 1km from Marine or Industrial environment
- Fence is installed to manufactures guidelines
- Fence is maintained regularly in accordance with suggestions made by Boundaryline.

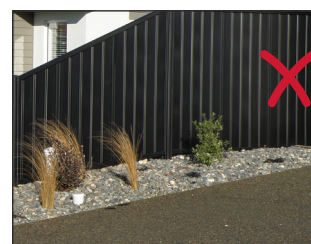

# WHY IS COLOURPANEL™ SO TOUGH?

ColourPanel™ materials are made from genuine ColourBond Steel. They are manufactured in Australia, using an advanced 5 step coating process as outlined below;

**Step 1.** A base of Zincalume steel ensures outstanding anti-corrosion performance.

**Step 2.** A conversion layer is chemically applied to enhance coating adhesion.

**Step 3.** A pre-treatment layer is applied to enhance the adhesion of further coatings.

**Step 4.** A polyester primer is baked onto the surface.

**Step 5.** A topcoat of specially developed exterior grade lead-free paint is baked on for maximum resistance to chipping, peeling and cracking. The Super Polyester technology ensures the painted finish retains its “as new” look for longer.

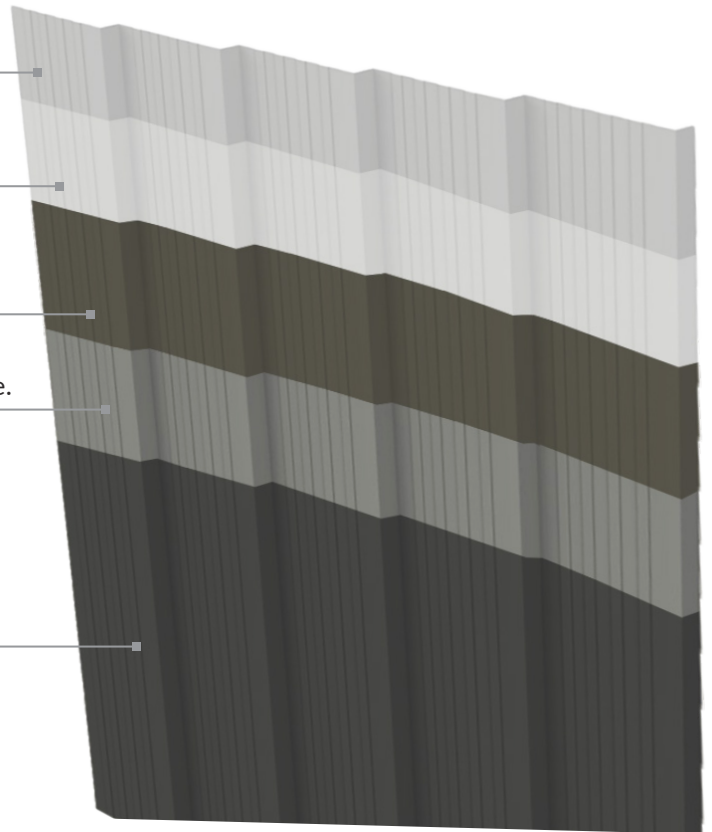

## CONTACT BOUNDARYLINE FENCING

ColourPanel™ Fencing is designed to withstand most wind conditions. The wind on the fence at your site will depend on a number of factors, including the number of surrounding properties and how exposed the location is.

If your property is exposed to higher wind speeds, please contact us for further advice/recommendations.

Also, if in proximity to severe marine conditions or bounding swimming pools, please seek specific advice from Boundaryline.

**BOUNDARYLINE'S TECHNICAL SUPPORT: 0800 003 006**

To learn more about COLOURPANEL™ visit: [www.boundaryline.co.nz/our-brands/colourpanel/](http://www.boundaryline.co.nz/our-brands/colourpanel/)

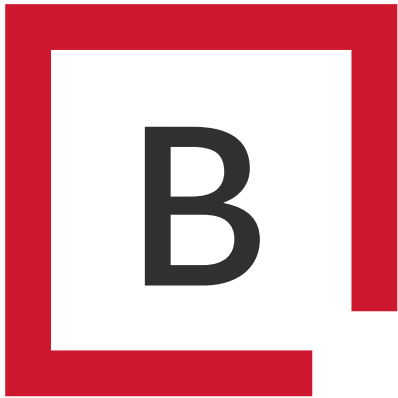

 Boundaryline

0800 003 006 / [boundaryline.co.nz](http://boundaryline.co.nz)