

# COLOURSLAT™

 Boundaryline

A STEP-BY-STEP GUIDE TO INSTALLING YOUR FENCE



# INSTALL GUIDE

# INTRODUCTION

Thank you for choosing Boundaryline ColourSlat™ Fencing. This product will provide you with many years of trouble free protection if installed in accordance with the directions outlined in this document.

The recommendations detailed in this guide are formulated along the lines of good building practice. They are not intended to be an exhaustive statement of all the relevant data.

If you have any questions, please contact our Technical Team on 0800 003 006. We are always happy to help in any way we can.

## BEFORE YOU START, READ THIS

- This guide does not apply to any fences over 1.8m in height. If your fence is greater than 1.8m, please seek further advice from Boundaryline.
- Describe your site details when ordering materials.
- Identify your soil type/ ground conditions. Refer to

the table in Step 1. This will determine the concrete and footing details required.

- Make sure you are aware of underground services before you start digging! These could be gas, electricity, or water mains. Call your local council for more information.

- Check your local council regulations on boundary fencing.

- Check the delivered material for the correct number of components and general condition before beginning your installation (see p.7).

## TOOLS LIST



- Make sure you choose the right tools before start installing your fence.

### TOOLS

- Tape Measure
- Square
- Shovel
- Circular Saw
- Hex Drive Bit
- Line Marking Paint
- String Line
- Drill/Driver
- Angle Grinder
- Post Hole Digger
- Spirit Level

### SAFETY GEAR

- Safety Boots
- Gloves
- Helmet
- Eye Protection
- Hearing Protection
- Sun Protection



It is recommended that the reader pays particular attention to those items identified as IMPORTANT in this manual to ensure satisfactory long-term performance.

# COMPONENTS LIST

SLOTTED POST INSERT

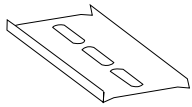

NOTCHED COLOURSLAT

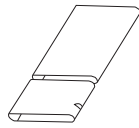

LOCKING PLUG

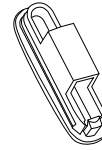

GROMMET

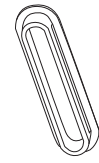

ANGLE

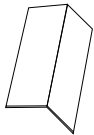

POST CAPS

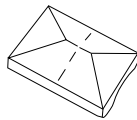

C POSTS

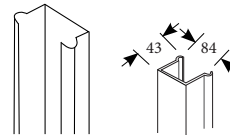

RAILS

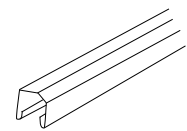



Standard ColourSlat™ panels are 2350mm wide which is also the standard length for Boundaryline rails. The slat length is determined by subtracting 40mm from the distance between your posts; eg. 2350mm panel will require 2310mm slat length.



Please ensure that the posts are installed no more than 2350mm (+10mm) apart.

## ITEMS REQUIRED FOR ONE PANEL (2350mm wide)

- Boundaryline Standard C Posts and Universal Rails (2 of each)
- Boundaryline Caps (2)
- Self-drilling screws Hex Head #10-16 (pre-painted) for joining posts to rails (See Table below for quantity)
- Wafer Head screw 10g 40mm GAL for securing Centre Vertical Slat (2)  
- One Slotted Post Insert pack (choose size) includes: One Slotted Post Insert prefitted with CNF-UP3 Grommets and One Slotted Post Insert prefitted with CNF-UP4 Locking Plugs
- Notched ColourSlat™ steel slats (See Table below for quantity)
- ColourSlat™ steel Centre Vertical Slat – pre-drilled including one pack of matching 4/5 Aluminium rivets. Quantity equals 1 per Slat
- Angle (300mm Fence Topper only- to attach Centre Vertical Slat to Base of Rail)

Fence Height (mm)	1800	1480	1163	300	1800	1435	1143
Slat Spacing	25mm	25mm	25mm	25mm	15mm	15mm	15mm
ColourSlat Quantity	21	17	13	3	23	18	14
ColourSlat Length	2310	2310	2310	2310	2310	2310	2310
Slotted Post Inserts (2)	1690	1373	1053	250	1690	1373	1043
Centre Vertical Slat (1)	1790	1470	1153	300	1790	1425	1133
Aluminium Rivets 4-5	21	17	13	3	23	18	14
Self-drilling wafer head screw #10-16 x 40	2	2	2	2	2	2	2
Neetascreen Post** (2)	2400	1800	1800	n/a	2400	1800	1800
Neetascreen Rail (2)	2350	2350	2350	2350	2350	2350	2350
Hex washer head prepainted #10-16 x 16 screw	24	20	18	n/a	24	20	18

\*\* Post size is dependent on whether the posts are installed in the ground or on a concrete slab.

# A STEP-BY-STEP GUIDE TO INSTALLATION

## STEP 1 - MARKING OUT YOUR POST HOLES

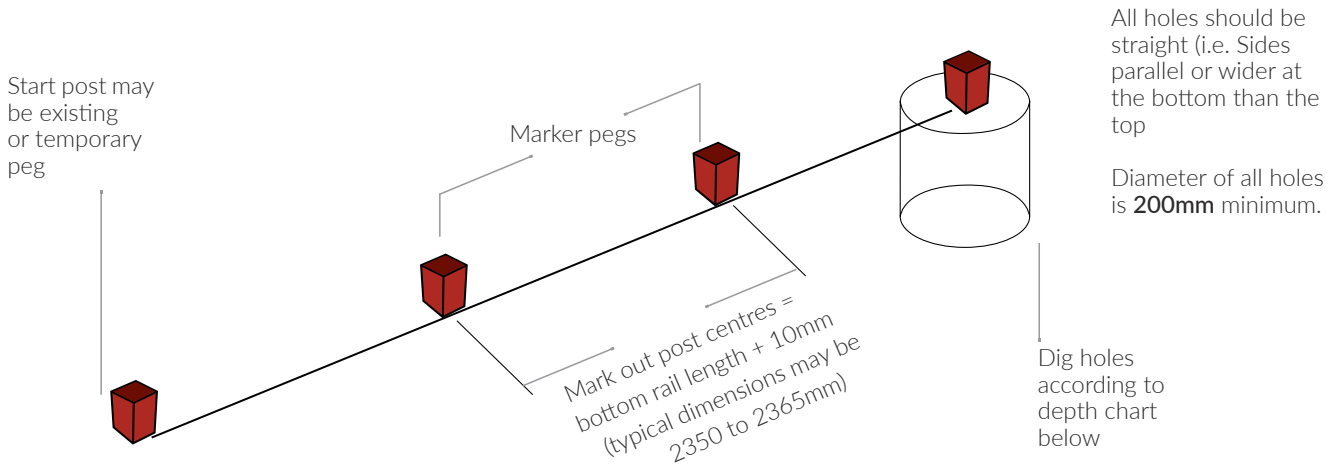

**IMPORTANT**

Post lengths required will increase accordingly to cater for these ground conditions.

Soil Type	Minimum Hole Depth	Approximate Concrete Required
Rock	300mm	1 bag per hole (20Kg bag)
Clay/Firm Earth	600mm	2 bag per hole (20Kg bags)
Sand/Loose Fill	900mm	3 bag per hole (20Kg bags)

## SLOPING OR UNEVEN SITES

### Uneven sites

Vertical slitting of sheets may be required if slope is greater than 1 in 8. This may reduce the three sheet coverage to a point where one of the sheets may require vertical slitting. On ColourPanel™ steel this can be achieved using a straight edge and scoring with a tungsten tipped hand cutter available at most hardware stores, then bending and snapping the sheet.

The top rail angles can be adjusted to create a smoother angle if desired. Note that the post height required will increase, so allow for this when fixing the posts in the ground.

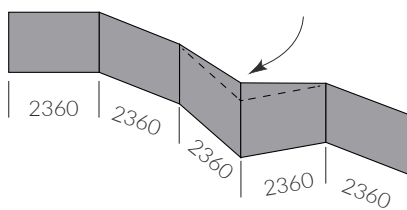

We have longer rails available, so when you have a slope in your fence line, you can keep your post centres at the standard intervals.

### a. Marking out sloping sites

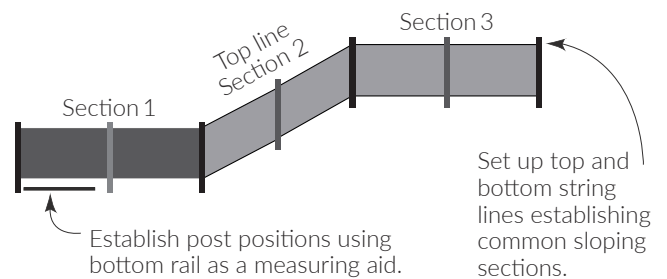

### b. Cutting of sheets for a raked fence

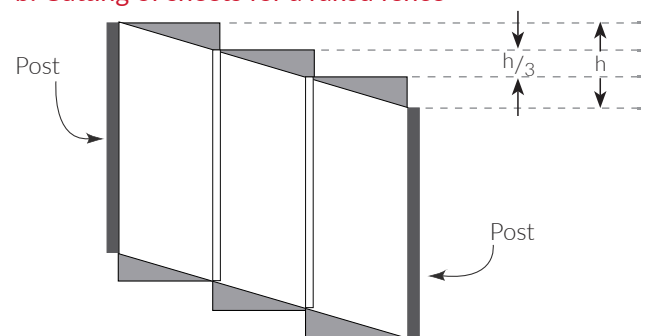

The preferred method of cutting sheets is to use a nibbler or tin snips.

## STEP 2 – SECURING POSTS

### a. Fastening posts together

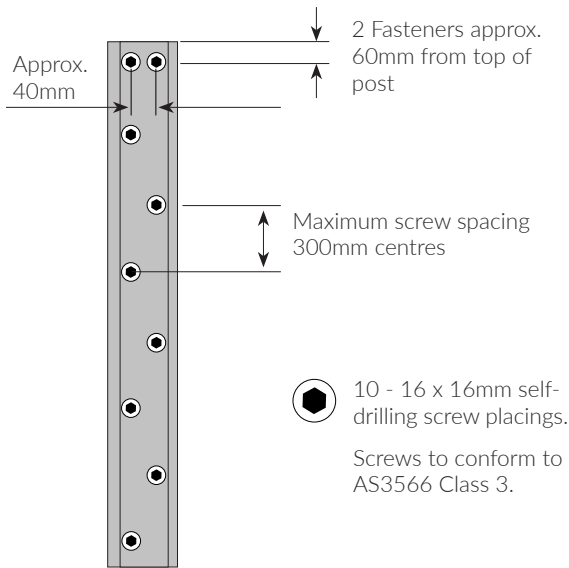

If it isn't possible to fix posts as proposed here, please contact us for further information.

### b. Fixing post in ground

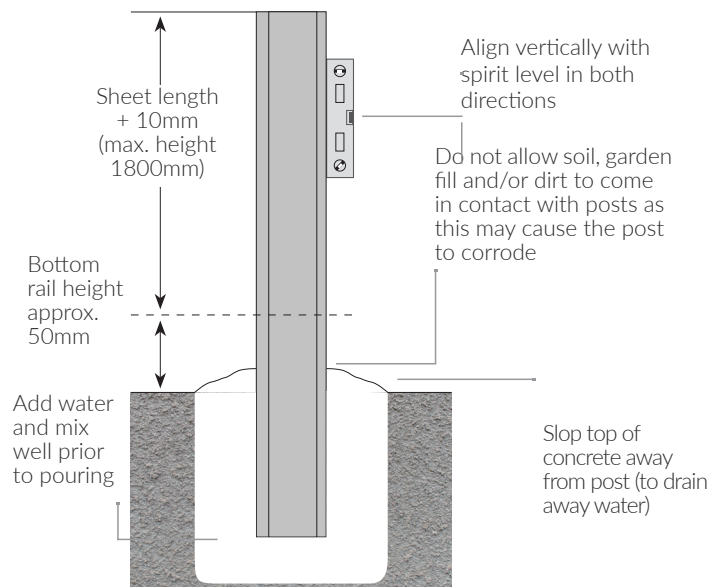

- Place first post in hole
- Adjust to correct height
- Support post with temporary brace
- Fill hole with fully mixed, wet concrete
- Vibrate and compact the concrete to remove voids.

## TYPICAL INSTALLATION OPTIONS FOR END POSTS, CORNER POSTS AND JUNCTIONS

□ - 65mm SHS Section    □ - Fence Post

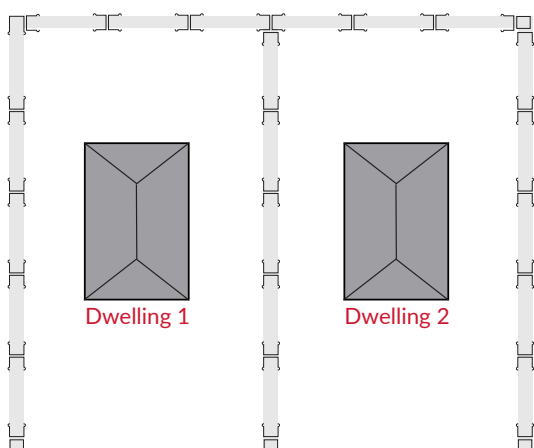
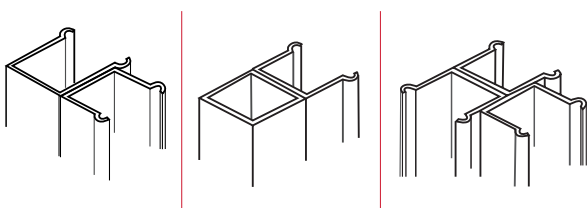

## TAPERING THE FRONT OF YOUR FENCE

It is highly recommended that you taper the last two panels of your fence at an unsupported end, particularly where your fence extends beyond the front of your house.

Cut sheets as per the instructions in the 'sloping or uneven sites' section.

The minimal extra effort in tapering the unsupported end will provide a better looking fence than a stepped fence and is much stronger than leaving it at full height.

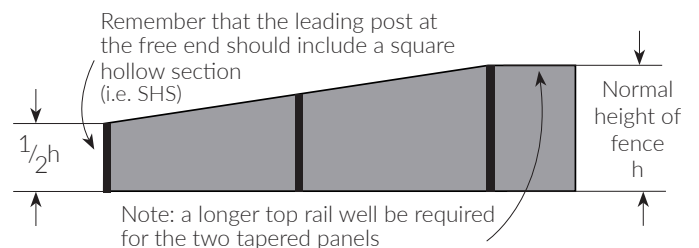

### Example for 2365mm post centres

Fence Height	Tapered End Height	Top rail length if tapered per two panels
1500mm	750mm	2385mm
1800mm	900mm	2400mm

ITEM	PART NUMBER	DESCRIPTION
1	SPI-xx	Slotted Post Insert
2	UNI3	Grommet
3	NMS-xx	Notched ColourSlat
4	Post-xx	Standard C Post
5	Rail-xx	Universal Rail
6	Cap-xx	Post Cap

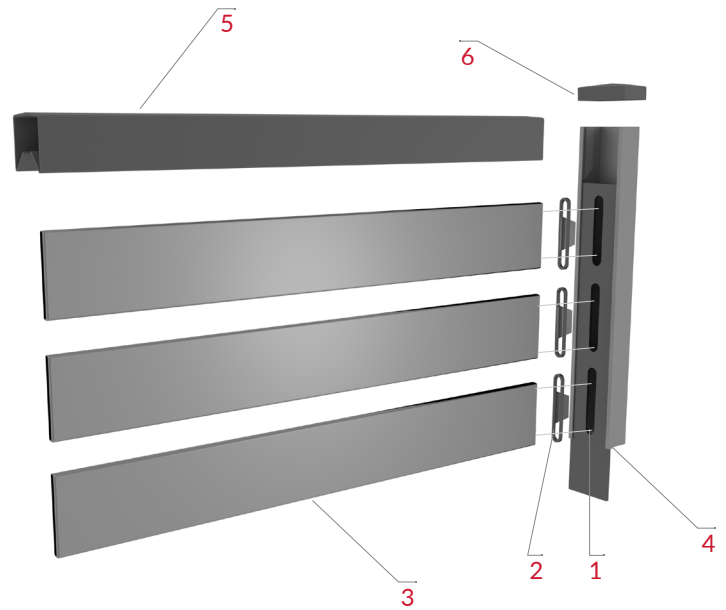

### STEP 3 – SLOTTED POST INSERTS

- Ensure locking plugs and grommets are fully seated into the Slotted Post Inserts. CNF-UH4 locking plugs go into one post insert and CNF-UP3 grommets go in the other post insert. Make sure the locking plugs are all the same with the lock point at the bottom of the slot.

- Remove top rail and insert Slotted Post Inserts with locking mechanism of the plug at the base or bottom of each hole. If you are facing the fence, the locking plug with the fully enclosed backing will be in the left-hand post. You are now ready to insert the slats.

### STEP 4 – INSERTING THE SLATS

- Pull back the core strip (plastic covering) from each end of the slat approximately 100mm. Each slat will have a small notch near the bottom of the left end.

- The slat's roll-formed seam should be at the top rear of the slat when it is inserted.

- Insert the slat into the top hole of the Slotted Post Insert by pushing it fully into the UP3 Grommet until it contacts the rear of the ColourSlat™ post. The other end of the slat will now be able to be pushed into the UP4 Locking Plug where it is pushed into the final locking position. You may need to move the slat up or down to get it past the edge of the ColourSlat™ post.

- Continue installing the slats until all slots are filled.

- Peel all plastic core strip from the installed slats and discard.

- Mark the centre of the top and bottom slats with a non-carbon pencil.

- Peel the corestrip (plastic covering) from the Centre Vertical slat just before use. The pre-drilled Centre Vertical Slat (CVS) is now placed in position by standing it in the centre of the bottom rail and moving it into position with the slats. The CVS is then riveted into position using the pre-drilled holes.

- Replace the top rail on the fence panel and secure with pre-painted self-drilling hex. head screws #10-16. One screw each side of each corner ie 8 per panel.

- Secure the CVS to the top and bottom rails using a 10G 40mm wafer head screw.



**Always start at the top as you may injure your fingers starting from the base if a slat slips and falls next to an inserted slat.**

## STEP 5 – INSTALLING POST CAPS

All ColourSlat™ caps are supplied as a 'double' cap, which are designed to be snapped in half to create two single caps where required.

### 1



Cut each side of the cap in line with the centre ridge. Use end-nippers – do not use a knife as this is dangerous and difficult to achieve a straight cut. Ensure the 'nose' of the end nippers is pushed all the way in before cutting.

### 2



Bend the cap along the centre ridge to snap it, and pull apart to create two single caps.

## NOTES

If the cap is not a tight fit, place a small amount of silicone up inside the cap to secure it. Make sure the silicone is a small bead on the inside corner of the sides only.



## MAINTENANCE AND WARRANTY OF YOUR FENCE

1. To keep your fence looking its best, simply wash down periodically with water when cleaning the car or watering the garden. A soft broom should be sufficient to remove any cobwebs. Pay particular attention to the area under the top rail, which is sheltered from natural washing by rain.

2. **DO NOT** build up soil, garden fill and/or dirt against the bottom rails and posts of your fence as this will retain water and lead to corrosion.

**DO NOT** use your fence as a retaining wall, as it is not designed for this purpose.

3. Avoid spraying the fence with garden sprays or fertilisers as these can damage the surface. If this occurs wash the fence down with water.

Adequate drainage is needed to ensure that water does not pond in the bottom rail and to assist in the removal of debris. This is often achieved by pre-punched holes in the bottom rail, or by designing the posts such that there is a clearance between the ends of the bottom rail and the posts.

4. **DO NOT** use touch up paint. Minor scratches should be left alone or the infill sheet replaced. Touch up paint will weather differently than ColourSlat™ steel. A small touch up brush can be supplied for any small scratches.

5. Fencing is backed by a 10-year warranty\* under the following conditions:

- Installation > 1km from Marine or Industrial environment
- Fence is installed to manufactures guidelines
- Fence is maintained regularly in accordance with suggestions made by Boundaryline.

## CONTACT BOUNDARYLINE FENCING

ColourSlat™ Fencing is designed to withstand most wind conditions. The wind on the fence at your site will depend on a number of factors, including the number of surrounding properties and how exposed the location is.

If your property is exposed to higher wind speeds, please contact us for further advice/recommendations.

BOUNDARYLINE'S TECHNICAL SUPPORT: 0800 003 006

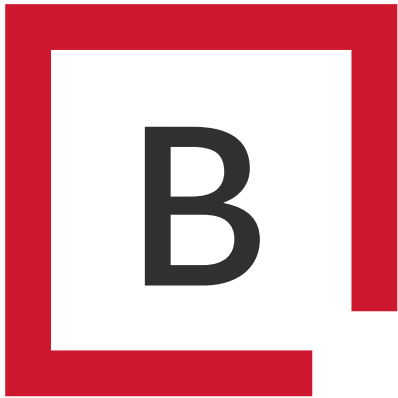

 Boundaryline

0800 003 006 / [boundaryline.co.nz](http://boundaryline.co.nz)