



 Boundaryline

# SentryPanel Install Guide

# Contents

SentryPanel Fence Components.....	03
SentryPanel Product Component Types.....	04
Step 1   Establish Fence Line.....	05
Step 2   Installing Posts.....	06
Step 3a   Attaching Brackets and Panels.....	07
Step 3b   Attaching Brackets and Raking Panels.....	08
Step 4   Fence Support Block - Playground Panel.....	09

## Before you start

**Read this entire install guide before beginning any installation.**

For guidance, information or advice, our technical team is available Monday to Friday, 7am to 5pm. Call us on 0800 003 006, or email [enquiries@boundaryline.co.nz](mailto:enquiries@boundaryline.co.nz)

Identify soil type/ground conditions to determine the required concrete and footing details.

Be aware of any underground services prior to commencing digging, identify the legal boundary and check local council regulations on boundary fencing. Contact the local council for more information.

For fencing over 1800mm contact Boundaryline for guidance.

For F4 (*Safety From Falling*) or F9 (*Restricting Access to Residential Pools*) applications, refer to the PS1 for installation details.

### Required Tools/Materials

- Tape measure
- Square
- Shovel
- Line Marking Paint
- String Line
- Spirit or laser level
- Drill/Driver
- Hex drive bit *5/16 driver*
- Auger/Post hole digger
- Circular Saw

### Safety Gear

- Safety boots
- Gloves
- Eye protection
- Hearing protection
- Sun protection

*Carefully read through the entire installation guide before commencing any installation work. Ensure measurements are correct before cutting components.*

# SentryPanel Fence Components

Take care when opening and unloading the package. Ensure all components are accounted for and check it is all undamaged.

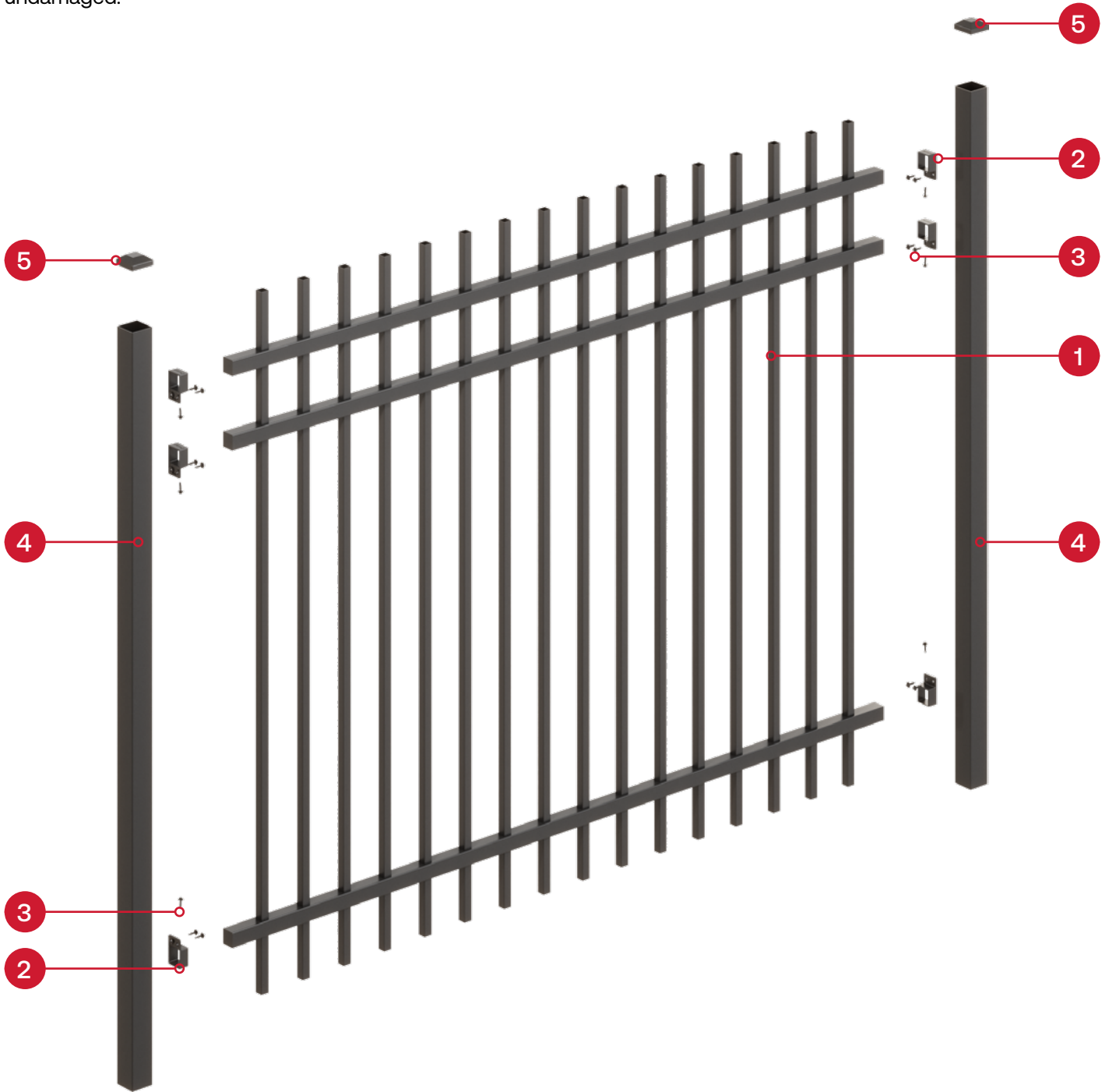

A complete SentryPanel Fence System consists of:

**1.** SentryPanel Panel



**2.** SentryPanel Brackets\*



**3.** Screws



**4.** Posts  
65x65mm

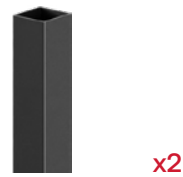



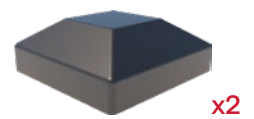

















**5.** Post Caps



\*Type and quantity of brackets depends on panel used. Refer to **page 04** for SentryPanel bracket types.

# SentryPanel Product Component Types

	Panel	Standard Brackets and Fixings	Raking Brackets and Fixings	Posts
Flat Top	 <p><b>Flat Top Panel</b> SAF1522-BK SAF1822-BK</p>	 <p><b>SentryPanel Bracket</b> SBK4040-BK</p>	 <p><b>SentryPanel Raking Bracket</b> SBZ4040-BK</p>	 <p><b>SentryPanel 65x65mm</b></p>
Playground Panel	 <p><b>Playground Panel</b> SPR9524-BK SPR1224-BK SPR1524-BK SPR1824-BK</p>	 <p><b>SentryPanel Bracket</b> SBK4040-BK</p>	 <p><b>SentryPanel Raking Bracket</b> SBZ4040-BK</p>	 <p><b>SentryPanel 65x65mm</b></p>
Rod Top	 <p><b>Rod Top Panel</b> SAR1822-BK</p>	 <p><b>SentryPanel Bracket</b> SBK4040-BK</p>	 <p><b>SentryPanel Raking Bracket</b> SBZ4040-BK</p>	 <p><b>SentryPanel 65x65mm</b></p>
School Panel	 <p><b>School Panel Panel</b> SAE-1522-BK SAE1822-BK</p>	 <p><b>SentryPanel Bracket</b> SBK4040-BK</p>	 <p><b>SentryPanel Raking Bracket</b> SBZ4040-BK</p>	 <p><b>SentryPanel 65x65mm</b></p>
Spear Top	 <p><b>Spear Top Panel</b> SAS1822-BK SAS2122-BK</p>	 <p><b>SentryPanel Bracket</b> SBK4040-BK</p>	 <p><b>SentryPanel Raking Bracket</b> SBZ4040-BK</p>	 <p><b>SentryPanel 65x65mm</b></p>

# Step 1 | Establish Fence Line

1. Hammer a wooden peg (or similar) into the ground at each end of the fence line. These represent the start and end points of your fence. If there is a corner or a change in direction, put a peg in at each of those points too. *Fig. 1*



*Fig. 1*

2. Tie a string line to the first marker peg, keeping the string line just off the ground. Run the string line along the pegs, from the beginning peg to the end, keeping the string line taut and straight with no sag. *Fig. 2*



*Fig. 2*

3. Once the string line is in place, measure along the line and mark where the post centres will be located with spray paint or a marker peg. *Fig. 3*

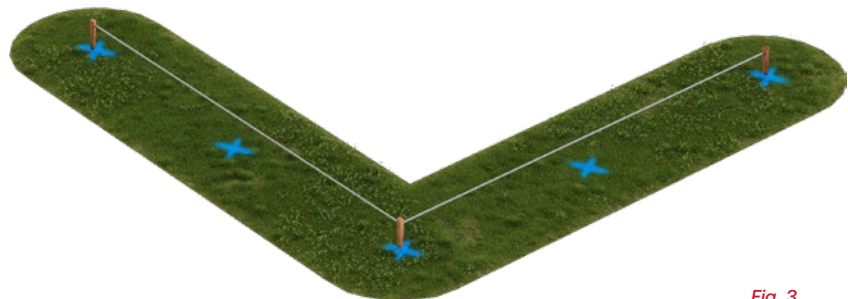

*Fig. 3*

To calculate the standard post centres for different SentryPanel styles, see the table below for some examples.

Style	Half width of post	+	Panel length	+	Half width of post	+	Clearance	=	Post centre
Standard Panels	32.5mm	+	2250mm	+	32.5mm	+	5mm	=	2320mm
Raking Panels*	32.5mm	+	2400mm*	+	32.5mm	+	5mm	=	2460mm

\*2400mm post centres for the raking panel is measured with the panel flat. The distance between post centres for the raking panel will decrease the more the panel has to rake.

# Step 2 | Installing Posts

## In-ground Posts

1. After marking post positions, dig the post holes. *Fig. 4*
2. Post hole depth will vary depending on ground conditions and fence height. All post holes should be at least 250mm in diameter, 600mm deep, and should be straight, with the sides either parallel, or wider at the bottom than the top. *Fig. 5*



Fig. 4

### Post Hole Depths:

Soil type	Min. hole depth	Approx. required concrete (20kg bag)
Clay/Firm Earth	600mm	2 bags per post hole
Sand/Loose Fill	900mm	3 bags per post hole

3. Brace the post into position, ensuring it is straight and level.
4. Pour in the concrete, allow at least 100mm of concrete below the post. Vibrate/compact the concrete to remove any voids.
5. Slope the top of the concrete to allow water to drain away from the post. *Fig. 6*
6. Check the posts are straight and level before the concrete fully sets.

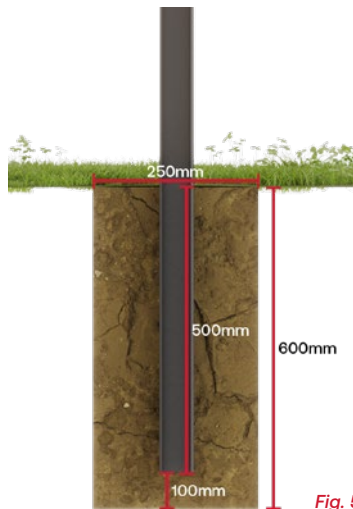

Fig. 5



Fig. 6

## Flanged Posts

1. Ensure the surface is firm, level and free of debris.
2. Align the posts along the surface.
3. Fix the posts into place using the correct type of fixings for the application.

*Fixings - indicative*

**In concrete:** 4x M12 concrete screw bolts with minimum 70mm embedment

**In timber:** 4x 12mm coachscrews with minimum 120mm embedment



Fixing details may vary for F4 or F9 compliance, please refer to the Boundaryline PS1 for guidance.

## Step 3a | Attaching Brackets and Panels

Once the concrete has set the panels and brackets can be attached.

If installing a raking panel, refer to [page 08](#).

The panels can be cut down to fit between posts if required. When cutting down panels, either a hacksaw or a power saw with a sharp diamond tip blade, or similar, is recommended to prevent burning the powder coat finish.

1. Slide the brackets onto the rails, ensuring the tab is pointing down for the top rail. *Fig. 7*  
The bracket on the bottom rail can have the tab pointing either up or down.
2. Measure and mark the positions of the brackets on the posts, and fit the panel into place between the posts. Check it is all straight and level then fix into place using the provided tek screws. *Fig. 8*
3. Using the provided tek screws, fix the panel into place through the tab side of the brackets. *Fig. 9*
4. Attach the post caps to the posts. *Fig. 10*

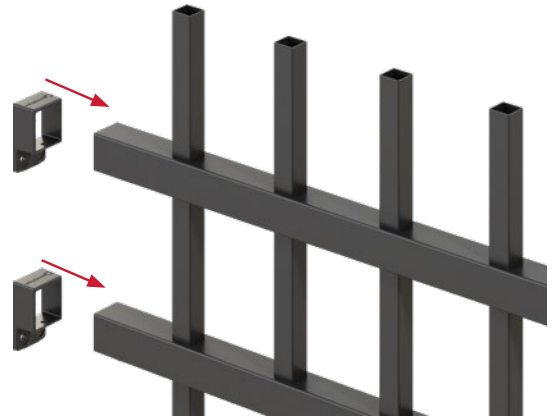

*Fig. 7*

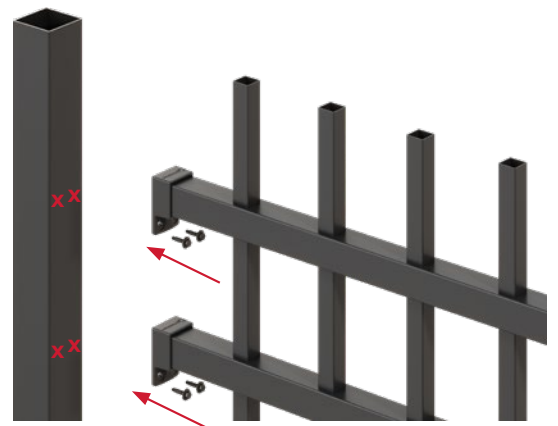

*Fig. 8*



*Fig. 9*

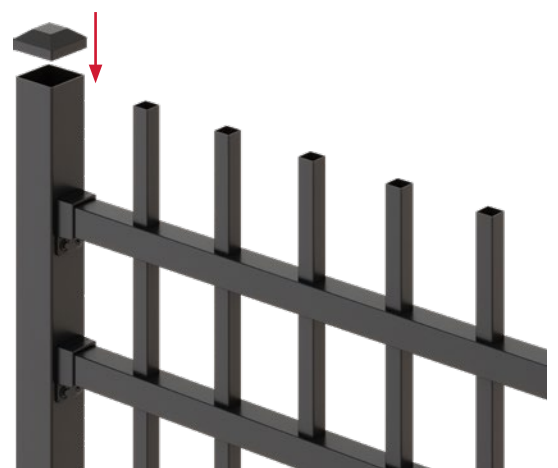

*Fig. 10*

## Step 3b | Attaching Brackets and Raking Panels

1. Fix the brackets to the posts. Once attached, fix one end of the panel to the brackets and adjust to required raking angle, then fix at the other end. *Fig. 11*
2. Attach the post caps to the posts



*Fig. 11*

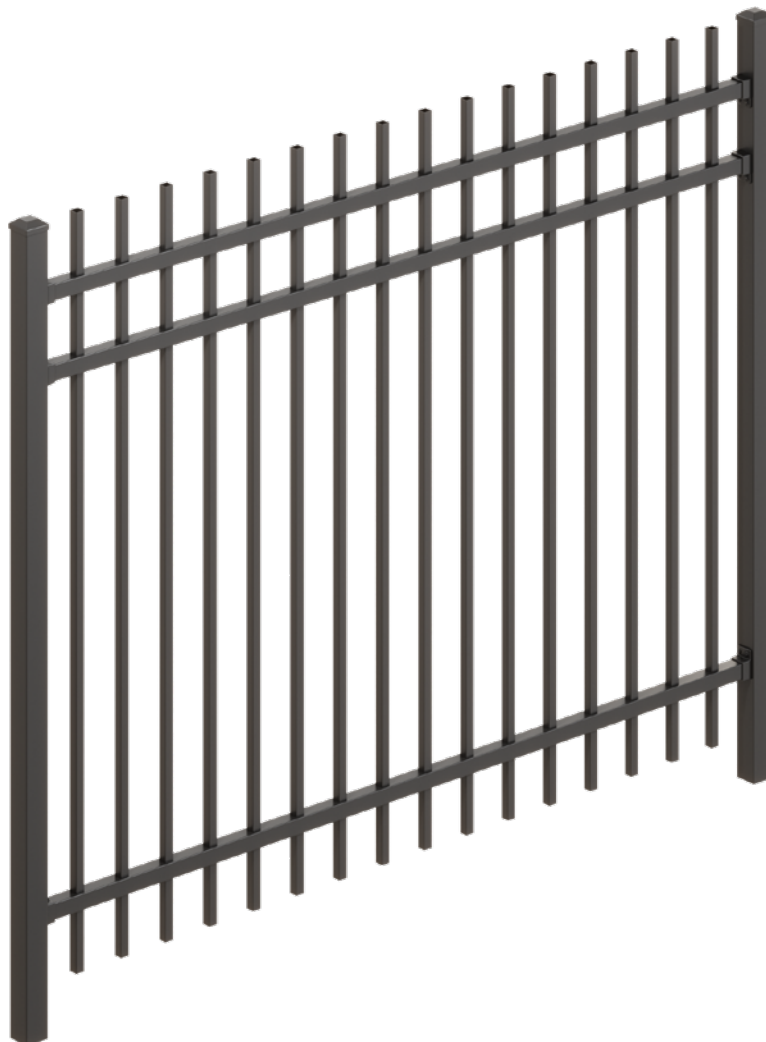

## Step 4 | Fence Support Block - Playground Panel

The following section outlines the recommended method for installing the Fence Support Block and highlights the key checks required to ensure the block provides support without lifting, twisting, or distorting the panel.

### Tools and materials required

- Fence Support Block Kit
- Saw for trimming block/support
- Drill with Phillips Head driver
- Tape measure, marker, ect,
- PPE

### Installation cautions

- Do not force the panel upward when fitting the support block.
- Do not install the block in a way that twists or distorts the bottom rail.
- Confirm the support block length and any cut angle before final fixing.
- Ensure the base beneath the block is firm and load-bearing.

### Installation method

1. Identify the centre picket of the panel and position the DDB5025-BK bracket on the underside of the bottom rail in line with this picket.
2. Fix the DDB5025-BK bracket securely to the underside of the bottom rail with the supplied pan head screws.
3. Measure and cut the Fence Support Block to the required length so it fits neatly between the bracket and the finished ground level. Where the panel is installed on a rake, cut the required angle on the block to suit the slope.
4. Fit the Fence Support Block into the DDB5025-BK bracket and secure it using the supplied pan head screws.
5. Where required, install an additional screw to lock the Fence Support Block in position and prevent it from pivoting within the bracket if knocked or disturbed.
6. Check that the support block is seated firmly and provides support to the bottom rail without lifting, twisting, or distorting the panel.

### Important note

A firm concrete surface, or other firm base is recommended wherever possible to provide reliable support for the Fence Support Block.

Ensure the panel is adequately supported and secured to suit the site conditions.



---

**Auckland**

43 Noel Burnside Road  
09 250 1144

**Christchurch**

19 Mānia Road  
03 347 3191

**Invercargill**

60 Basstian Street  
03 211 5145

**0800 003 006**

**[enquiries@boundaryline.co.nz](mailto:enquiries@boundaryline.co.nz)**

**[boundaryline.co.nz](http://boundaryline.co.nz)**

---

**Please note:** This document is only intended to be a general guide, as every property and situation is different. All measurements are provided as a general guide. For detailed specifications, including full technical drawings and PS1 documents (where applicable), please refer to our website.

Any installation work, including the use of power equipment is completely the responsibility of the person(s) installing.

All persons using power equipment must be trained and certified to use the equipment and must wear all applicable personal protection gear.

Boundaryline Limited cannot accept any responsibility for any faulty installation or damage or injury arising from installation work.

Our team is available 7am - 5pm, Monday to Friday on 0800 003 006 or email us at [enquiries@boundaryline.co.nz](mailto:enquiries@boundaryline.co.nz).