

 Boundaryline

Sleek**Wall** Solid Install Guide

Contents

SleekWall Fence Components.....	03
Important Information SleekWall Solid.....	04
Step 1 Establish Fence Line.....	05
Step 2 Installing Posts.....	06
Step 3 Attaching Paling Channels.....	07
Step 4 Fitting Palings.....	08
Step 5 Cover Clip and Channel Caps.....	09
Vertical Conversion Conversion Guide.....	10
Vertical Conversion Attaching The Base.....	11
Vertical Conversion Fitting The Palings.....	12

Required Tools/Materials

- Tape measure
- Square
- Shovel
- Line Marking Paint
- String Line
- Spirit or laser level
- Drill/Driver
- Hex drive bit *5/16 driver*
- Auger/Post hole digger
- Circular Saw/Other Saw

Safety Gear

- Safety boots
- Gloves
- Eye protection
- Hearing protection
- Sun protection

Carefully read through the entire installation guide before commencing any installation work.
Ensure measurements are correct before cutting components.

SleekWall Fence Components

Take care when opening and unloading the package. Ensure all components are accounted for and check it is all undamaged.

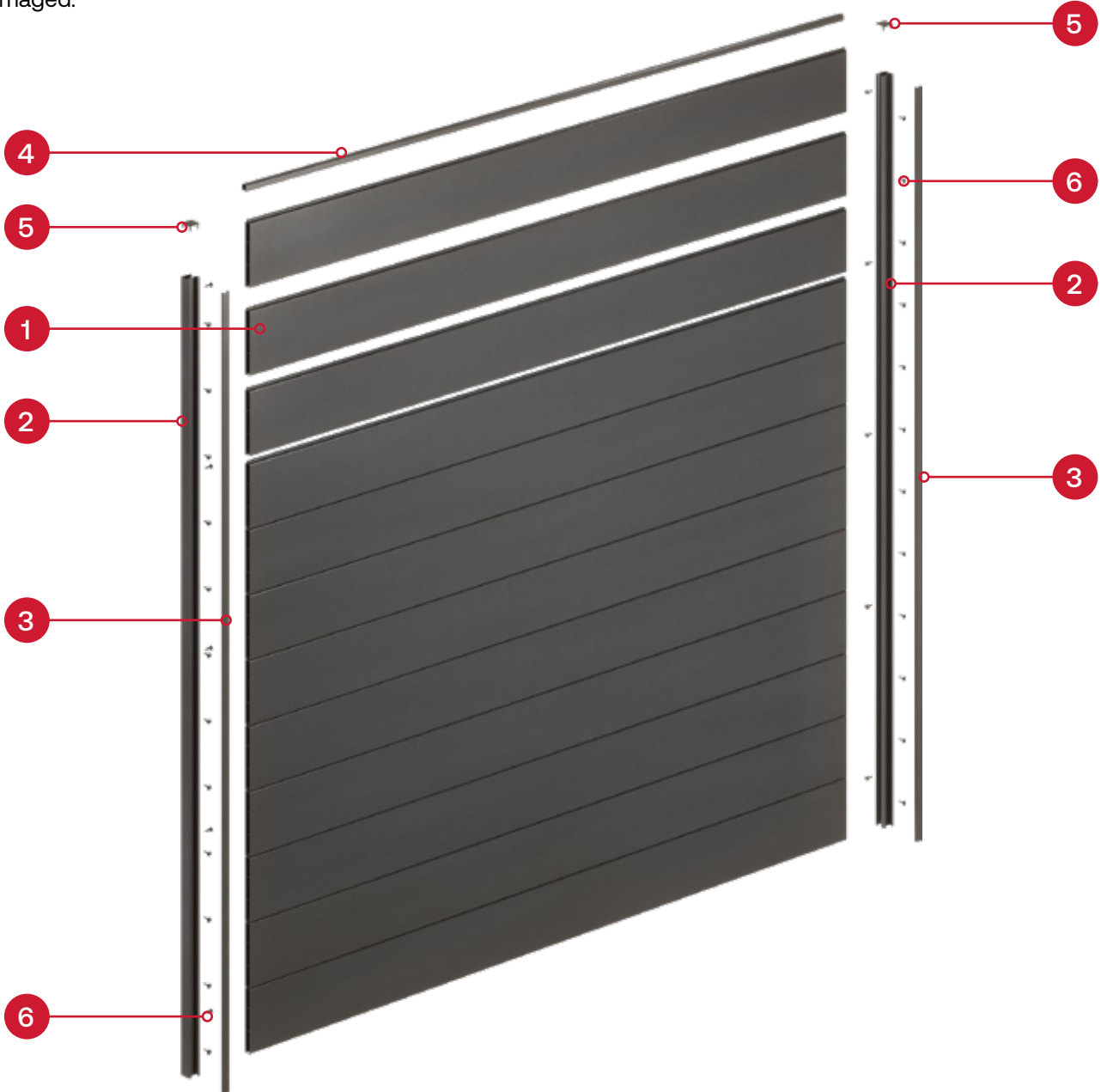

A complete SleekWall Fence System consists of:

1. Palings
140x16x1780mm



2. Channels
(left and right)

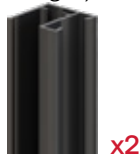

3. Channel Cover Clip

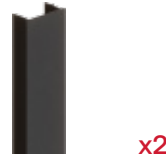

4. Tongue Cover



5. Channel End Caps (left and right)



6. Tek Screws



100x16mm Slat*

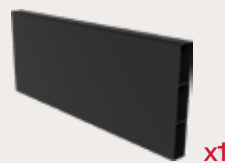

Additional Slat Channels and Covers**



*Additional components supplied if converting SleekWall to vertical orientation. Vertical conversion guide shown on [page 12](#).
65x65mm Posts and Caps supplied separately.

Important Information | SleekWall Solid

For guidance, information or advice, our technical team is available Monday to Friday, 7am to 5pm.
Call us on 0800 003 006, or email enquiries@boundaryline.co.nz

Installing SleekWall Solid vertically will have different post centre measurements to the horizontal orientation.
The vertical conversion guide is on [page 10](#).

Compliance

Please refer to the PS1 for full compliance details.

F9 (Safety for Residential Pools)

SleekWall Solid Horizontal and Vertical are compliant for F9 at all heights, with adjustments to the post centres. Refer to the SleekWall PS1 for guidance.

F4 (Safety From Falling)

SleekWall Solid Horizontal and Vertical are compliant for F4 at all heights, with adjustments to the post centres. Refer to the SleekWall PS1 for guidance.

SleekWall Components

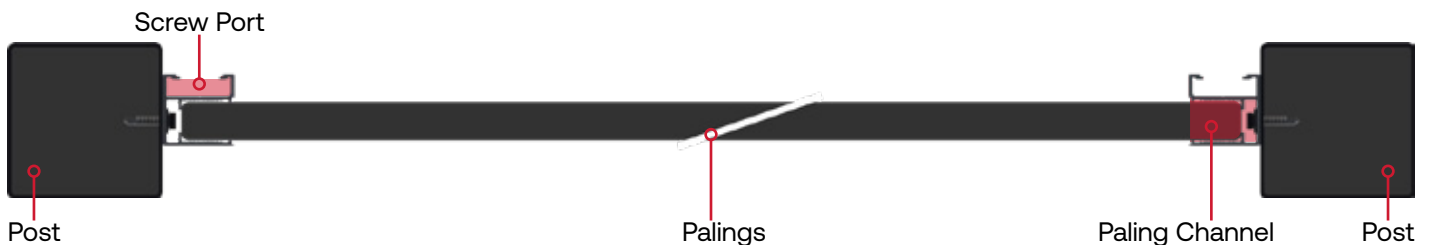

SleekWall Measurement References

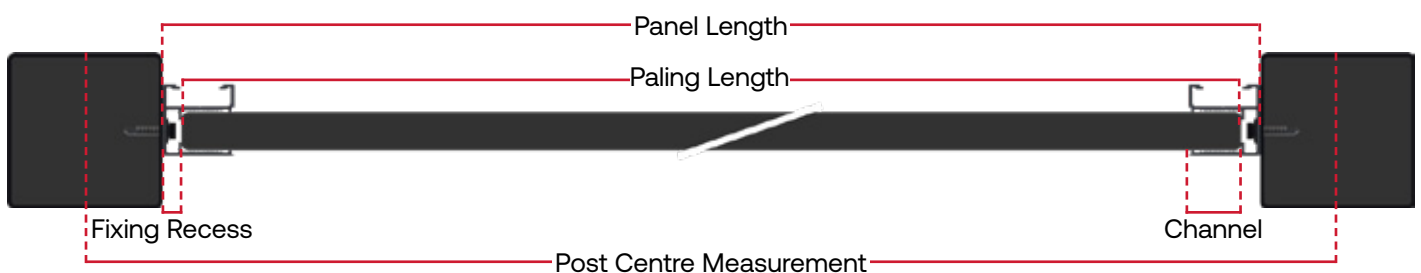

Step 1 | Establish Fence Line

1. Hammer a wooden peg (or similar) into the ground at each end of the fence line. These represent the start and end points of your fence. If there is a corner or a change in direction, put a peg in at each of those points too. *Fig. 1*
2. Tie a string line to the first marker peg, keeping the string line just off the ground. Run the string line along the pegs, from the beginning peg to the end, keeping the string line taut and straight with no sag. *Fig. 2*
3. Once the string line is in place, measure along the line and mark where the post centres will be located with spray paint or a marker peg. *Fig. 3*
4. To calculate standard SleekWall post centres measure the paling length (1780mm or 2380mm as standard), add 65mm for the post size, and add 20mm to allow for the fixing recess space on both sides.

The palings can be cut down to achieve even bay spacing across the entire fence line, instead of ending up with one narrow bay one end.

TIP Lay out your posts and rails along the fence line to establish the post positions before commencing digging *Fig. 5*



Fig. 1



Fig. 2

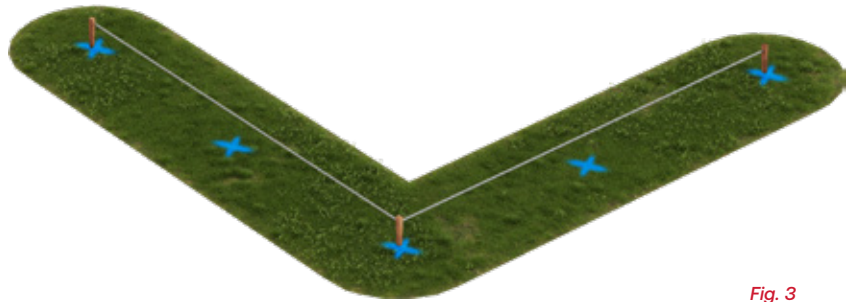

Fig. 3

Calculating Standard Post Centres SleekWall Horizontal

Paling length	+	Fixing Recess Space	+	Post size	=	Post centre
1780mm	+	20mm	+	65mm	=	1865mm
2380mm	+	20mm	+	65mm	=	2465mm

Calculating Standard Post Centres SleekWall Vertical

Bottom slat length*	+	Fixing Recess Space	+	Post size	=	Post centre
1755mm	+	20mm	+	65mm	=	1840mm

*Maximum panel width is dictated by the length of the channel (1755mm)

Step 2 | Installing Posts

In-ground Posts

1. After marking post positions, dig the post holes. *Fig. 4*
2. Post hole depth will vary depending on ground conditions and fence height. All post holes should be at least 250mm in diameter, 600mm deep, and should be straight, with the sides either parallel, or wider at the bottom than the top. *Fig. 5*

Post Hole Depths:		
Soil type	Min. hole depth	Approx. required concrete (20kg bag)
Clay/Firm Earth	600mm	2 bags per post hole
Sand/Loose Fill	900mm	3 bags per post hole

3. Brace the post into position, ensuring it is straight and level. Ensure there is enough height to allow for the paling height, ground clearance (50-100mm is recommended) and an additional 10mm at the top for an external post cap.
4. Pour in the concrete, allowing at least 100mm of concrete below the post. Vibrate/compact the concrete to remove any voids.
5. Slope the top of the concrete to allow water to drain away from the post. *Fig. 6*
6. Check the posts are straight and level before the concrete fully sets.

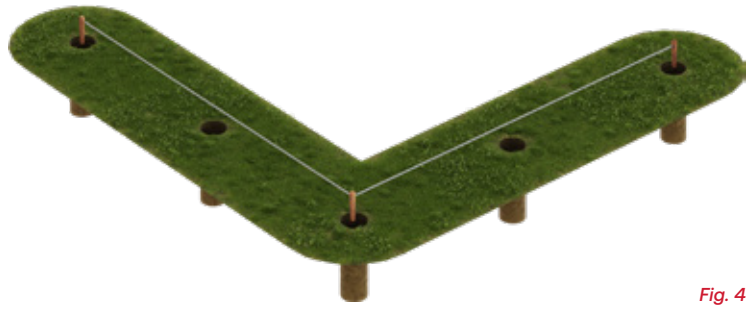

Fig. 4

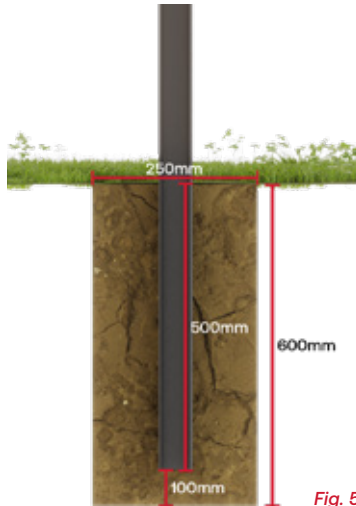

Fig. 5



Fig. 6

Recommended footing depths listed in the above table are for wind regions A and B, plus terrain categories 2.0, 2.5 and 3.

If you are building your fence in a cyclonic wind area, on top of a hill, adjacent to an escarpment, on a ridge or in terrain category 1, you will need engineering advice beyond the scope of this install guide.

Flanged Posts

1. Ensure the surface is firm, level and free of debris.
2. Align the posts along the surface.
3. Fix the posts into place using the correct type of fixings for the application.

Fixings (indicative)

In concrete: 4x M12 concrete screw bolts with minimum 70mm embedment

In timber: 4x 12mm coachscrews with minimum 120mm embedment



Fixing details may vary for F4 or F9 compliance. Please refer to the Boundaryline PS1 for guidance.

Step 3 | Attaching Paling Channels

The paling channels are 1755mm long, and are designed to suit an 1800mm high fence. For shorter fence heights, the channels will need to be cut to size.

A drop saw or circular saw are recommended for cutting components. Tools like angle grinders can burn the powder coat finish.

1. Measure and mark the correct position of the paling channels on each post. *Fig. 7*
Allow at least 10mm clearance at the top of the post to accommodate an external-fit post cap. *Fig. 8*
Allow 50–100mm clearance at the bottom of the fence. Use a string line or laser level to ensure consistent alignment across the fence line.

On sloping ground, the fence may need to be stepped to follow the contour of the site.

2. Each bay requires a left and right channel, which will mirror each other between the posts. *Fig. 9*
Ensure all channels have the screw port facing the same direction across all bays for a consistent appearance (typical installs have the screw port on the inside of the property).
3. Attach the paling channels to the posts using the provided tek screws, spacing them 300–400mm apart down the length of each channel. *Fig. 10*



Fig. 7



Fig. 8

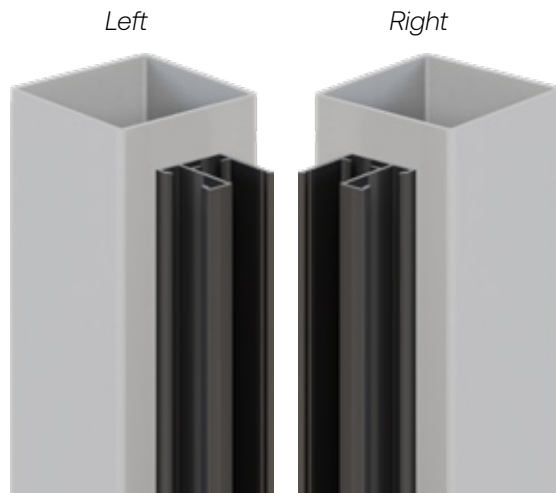

Fig. 9



Fig. 10

Step 4 | Fitting Palings

If installing vertical orientation, see vertical conversion guide on [page 10](#).

1. With the tongue side pointing up, slide the first paling to the bottom of the channels, ensuring the paling is level. Fix the paling into place at both ends through the screw ports. *Fig. 11, Fig. 12*
2. Slide in the following palings and fix each one into place.
3. Once all palings are fitted and fixed into position, place the tongue cover over the top paling. *Fig. 13*

Recommended practice is to install all fence bays before attaching channel cover clips, as they are difficult to remove without causing damage if any adjustments to the fence are required.

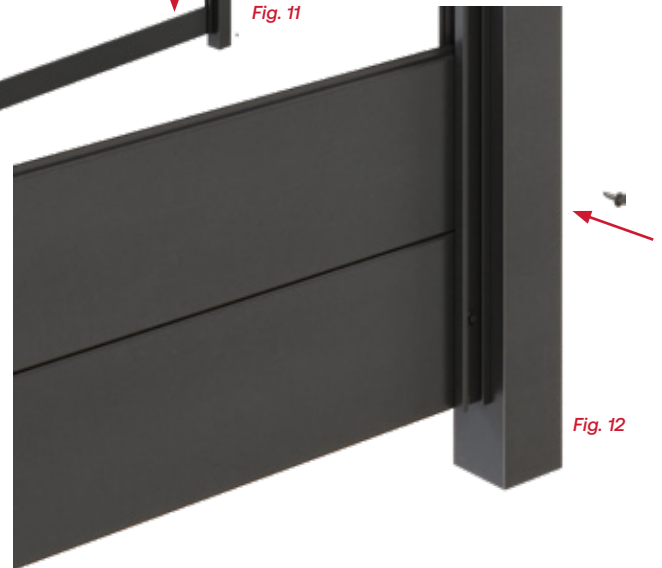
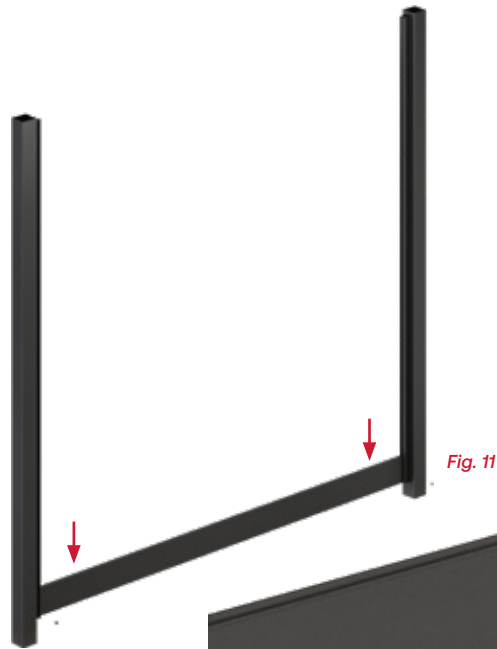

Step 5 | Cover Clip and Channel Caps

Recommended practice is to get all fence bays installed up to this point before installing the cover clips as they are difficult to remove without causing damage to the components. This will give the opportunity to ensure the entire fence is even and aligned.

Once all the fence bays are installed:

1. Cut the cover clip to the same length as the paling channel if required. *Fig. 14*

2. Insert one edge of the cover clip into the channel. *Fig. 15*

3. Using a rubber mallet (or similar) firmly tap the other edge of the cover clip to clip it into place. Continue to tap the cover clip into place down the length of the channel.

It's important to use an object that won't damage the powder coat finish.

4. Once the channel cover clip is in place, the channel caps can be inserted into the top of the channel, and the posts caps added to the posts. *Fig. 16*

A left and right channel cap are supplied for each bay for their respective channels.



Fig. 14



Fig. 15

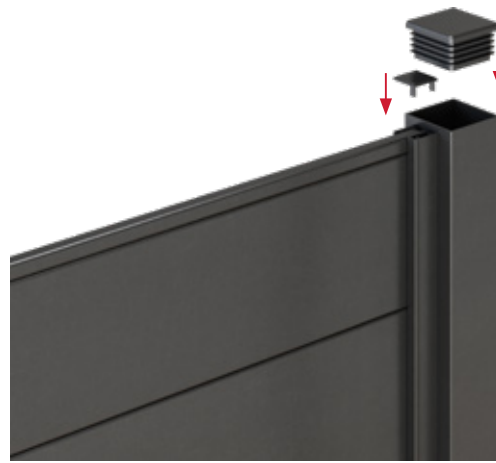

Fig. 16



Vertical Conversion | Conversion Guide

SleekWall Solid can be changed to a vertical orientation using the vertical conversion kit. The vertical conversion kit contains an extra set of channels and cover clips, and one extra slat.

Due to the length of the channels, SleekWall Vertical Solid's maximum height is 1755mm and the maximum distance between the inner post faces is 1775mm wide, with 1840mm between post centres.

The bottom slat will need to be cut to fit between the posts, minus an extra 20mm to allow for the fixing recess space. For the standard panel width, the bottom slat will be 1755mm, see [page 05](#) for calculating post centres. The vertical palings will also require trimming to fit. For the standard panel height, the maximum vertical paling length will be 1635mm. See the below table for the method.

Vertical Palings Length:						
Panel Height	-	Bottom slat height	-	Channel recess	=	Vertical paling length
1755mm	-	100mm	-	20mm	=	1635mm

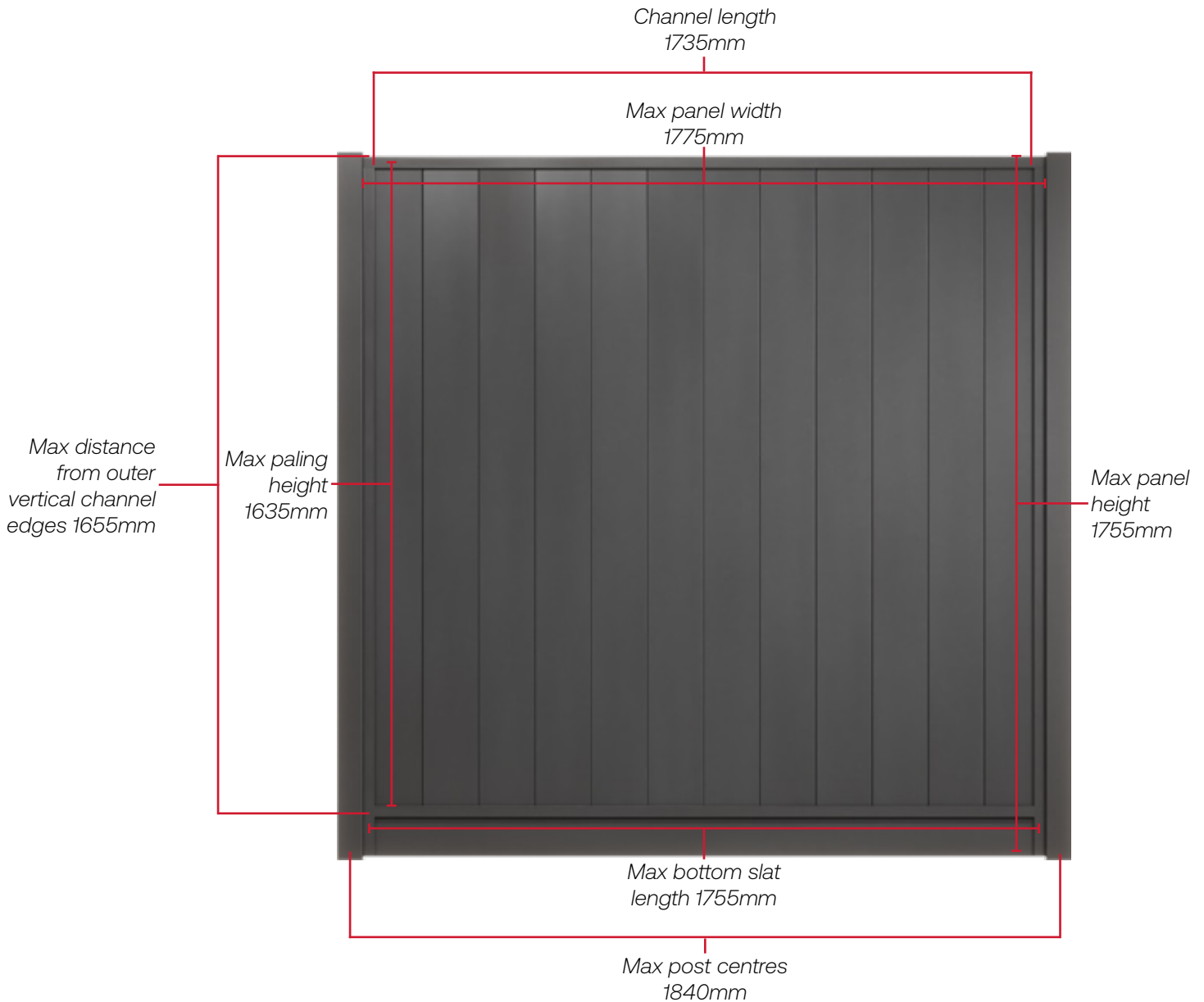

Vertical Conversion | Attaching The Base

1. Attach the vertical paling channels to the posts.
2. Cut the bottom slat to the correct width and insert horizontally into the channels and fix into place with the provided tek screws. *Fig. 22, Fig. 23*
3. Lay the channel on top of the horizontal slat, ensuring the screw port sides are all facing the same direction. *Fig. 24, Fig. 25*
4. Fix the channel to the top of the slat through the fixing recess. This will act as the base for the vertical palings. *Fig. 26*

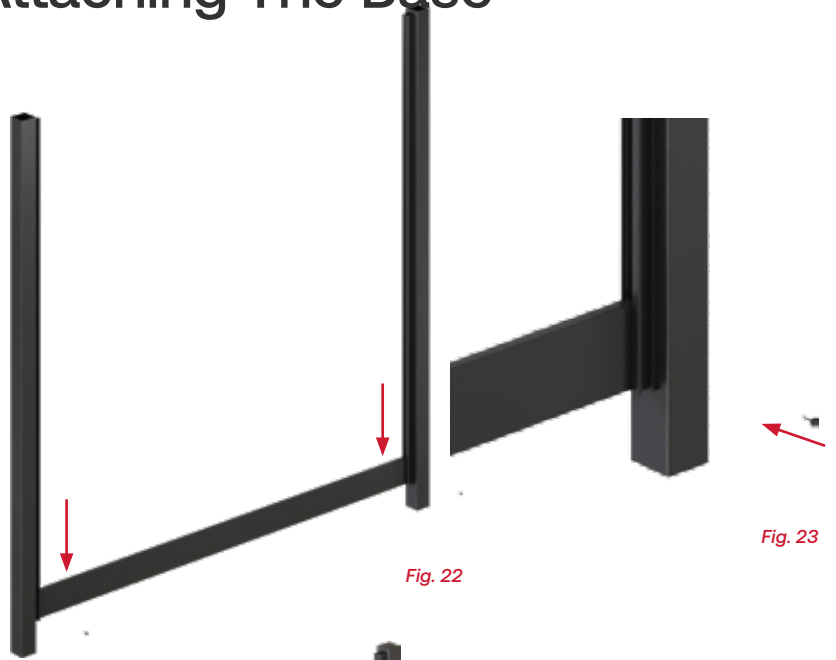

Fig. 22

Fig. 23

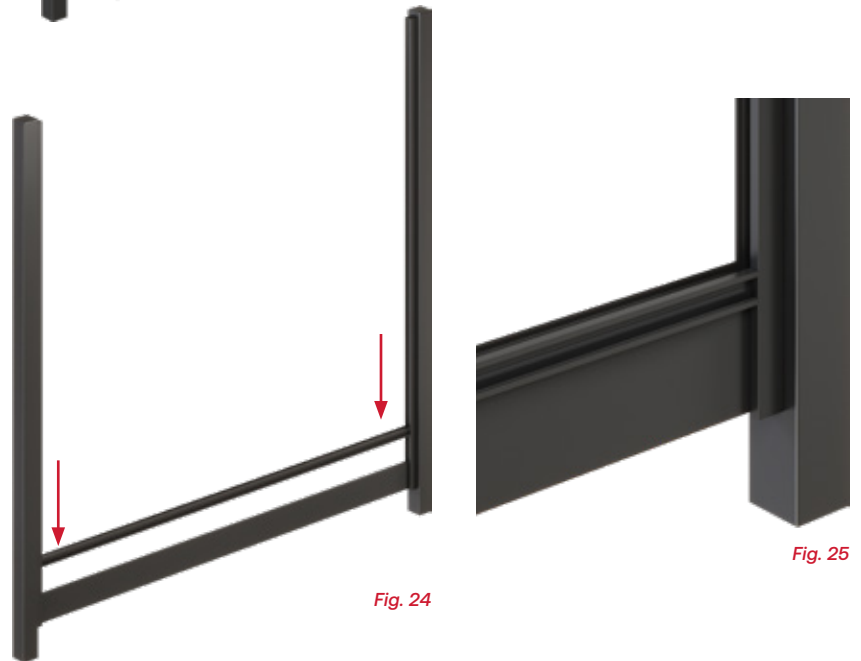

Fig. 24

Fig. 25

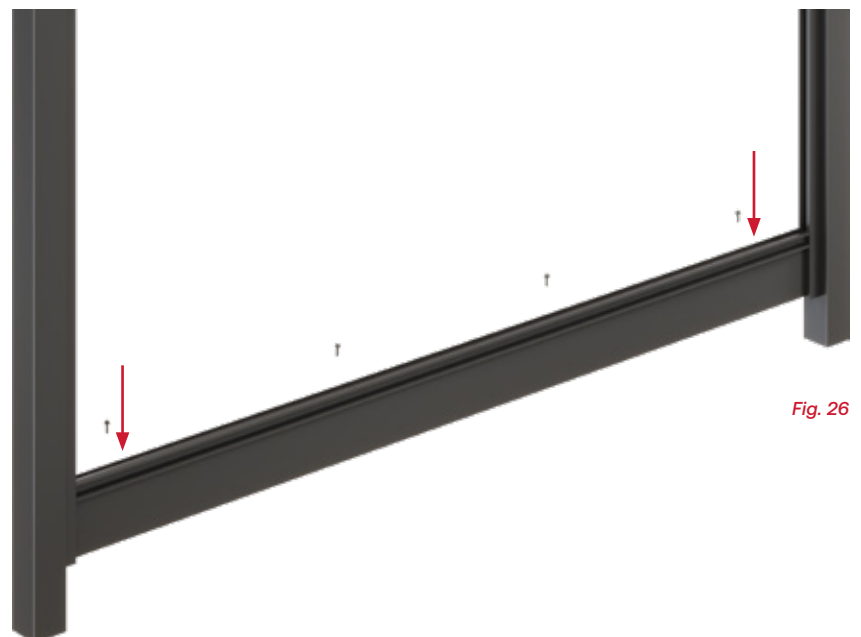

Fig. 26

Vertical Conversion | Fitting The Palings

1. Starting from one side, sit the first paling into position in the channel and fix into place through the screw port. *Fig. 27, Fig. 28*
The top of the palings will be loose until all the palings and final channel is installed.
Tying a strap (or similar) to the palings can secure them prior to fitting the top channel.
2. Once all the palings are attached in the bottom channel, the top channel can be sat into place. *Fig. 29*
3. Check everything is aligned and looks correct and fix the top end of the palings into place. *Fig. 30*
Installing all fence bays up to this point is recommended before attaching the channel cover clips.
4. Attach the channel cover clips and channel end caps to all the channels, and attach the post caps to the posts. *Fig. 31*

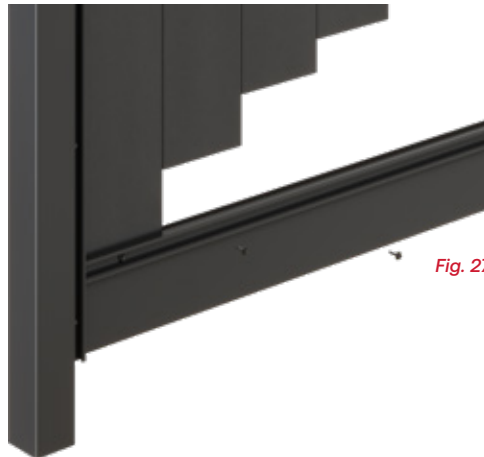

Fig. 27



Fig. 28



Fig. 29



Fig. 30



Fig. 31



Auckland

43 Noel Burnside Road
Wiri

Christchurch

19 Mānia Road
Hornby South

Invercargill

60 Basstian Street
Prestonville

0800 003 006

enquiries@boundaryline.co.nz

boundaryline.co.nz

Please note: This document is only intended to be a general guide, as every property and situation is different. All measurements are provided as a general guide. For detailed specifications, including full technical drawings and PS1 documents (where applicable), please refer to our website.

Any installation work, including the use of power equipment is completely the responsibility of the person(s) installing.

All persons using power equipment must be trained and certified to use the equipment and must wear all applicable personal protection gear.

Boundaryline Limited cannot accept any responsibility for any faulty installation or damage or injury arising from installation work.

Our team is available 7am - 5pm, Monday to Friday on 0800 003 006 or email us at enquiries@boundaryline.co.nz.